



RED SEAL
MEASUREMENT

C-12
Rev. J

Industrial Liquid Measurement Systems

For Batching and Challenging Liquid Phase Flows

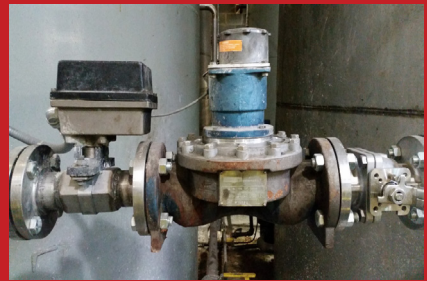

Technology for the Way You Work

featuring

neptune

meters and registers

www.redsealmeasurement.com

If you can pump it...

Red Seal Measurement can measure, batch, inventory or load it, with accuracy and reliability.

Our flow measurement systems have been known for over a century for robust performance, ease of use and wide ranging capability. The company is active in more than 30 countries with more than 300 distributors worldwide.

In your daily quest for efficiency, Red Seal Measurement is the name you can trust for accuracy and dependability, now as always.

We focus sharply on our core technology; metering products, advanced electronic systems and services that measure, communicate and process data for liquid phase flows.

To capitalize on this strength, our portfolio of advanced electronic systems that provide data/information management, particularly relating to transactions and inventory control. Backing this recognized technological know-how is a solid industrial base and strong sales force.

In engineering, customer service and administrative functions, customer orientation best describes our attitude. This emphasis merges the bottom-up flow of ideas with customer feedback to stimulate a lively atmosphere of focused product innovation and refinement. In manufacturing operations, Continuous Quality Improvement methods certified under ISO 9001-2000 standards ensure each operation in the plant remains within established tolerances.

This customer orientation extends to the field. Applications specialists at the Greenwood plant back up each of our field representatives. Regular factory training ensures that field technicians can keep every Red Seal Measurement flowmeter providing as-new performance.

The NexGen® SFT 100™ Mass Flow Transmitter with Digital Signal Processing (DSP) and open architecture is easy for users to install and configure.



Red Seal Measurement technologies include:

- **Coriolis mass flow measurement:** mass flow technology is proven in troublesome applications, offering high accuracy in noisy, viscous flows.
- **Mechanical flowmeters:** Processors worldwide rely upon Red Seal Measurement's proven designs for cost-efficient accuracy and field-serviceability. Featuring magnetically coupled drives, leak-resistant static seals and touch polymer measuring elements that work well with suspended solids.
- **Electronic registration:** Red Seal Measurement offers electronic registers with the flexibility to control batching locally or interface with supervisory control. Our electronic registers are the ones you can grow with.

Mass Measurement Flexibility for Challenging Applications

Red Seal Measurement's Coriolis mass flowmeters employ application-focused technology for precision mass- and density-based control over the most difficult batching and transfer flows. A large installed base represents a wide range of applications.

- Unmatched 100:1 turndown across the line
- Unequaled low pressure drop
- Patented, dual omega-shaped flow tube design has exceptional Coriolis sensitivity
- No need to sacrifice accuracy to maintain line pressure

This mass flowmeter provides excellent Coriolis sensitivity at low flow, making it ideal for viscous fluids. The Coriolis mass measurement principle gives the flowmeter high accuracy regardless of changing temperature.

Consistent accuracy under changing conditions enabled the flowmeter to provide tighter process control, lower process variability and enhanced statistical process control. This pays off in reduced waste and off-spec, especially during startups and process swings. Additionally, setup and changeover times are less than with alternate methods.

The smooth omega flow path withstands abrasives and vibration better than other designs. There are no moving parts.

The Red Seal Measurement Coriolis Mass Flowmeter offers direct measurement of mass flow, density and temperature in a single package.

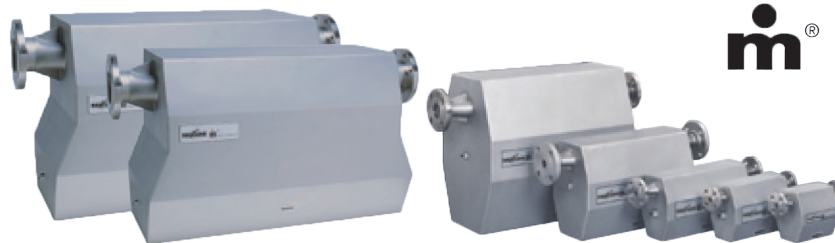

Red Seal Measurement offers a broad range of Coriolis mass meters with flow rates ranging from 0.09 kg/min (0.20 lbs/min) on the 1/8" M012 model to 6,804 kgs/min (15,000 lbs/min) on the 4" M400 model. All models are available with different flange sizes and pressure ratings to meet all application requirements.

Three transmitter models (NexGen SFT100, Datamate 2200 and NexGen SFT200) are available to meet all specifications for hazardous areas, remote or integral installations, batching and blending and many other functions required for industrial use.

All our mass meter models have NTEP approval for custody transfer applications by mass or volume. The transducers are intrinsically safe and the transmitters have UL/CSA and ATEX approvals for explosion proof or intrinsically safe ratings.

To aid in your selection of the meter that best fits your application, a copy of our Expert Selection Program can be downloaded from our website www.redsealmeasurement.com.

Meter	Model	Mass Flow Range	
		kg/min	lb/min
1/8"	m012	0.09-9.0	0.2-20
1/4"	m025	0.36-36.0	0.8-80
1/2"	m050	1.36-136	3-300
1"	m100	5-500	11-1100
2"	m200	14.5-1450	32-3200
3"	m300	41-4,082	90-9,000
4"	m400	68.0-6804	150-15,000



The NexGen SFT100 Mass Flow Transmitter is open and flexible for easily enhanced and modified capabilities.

NexGen® SFT100™ Mass Flow Transmitter

The NexGen® SFT100™ is the first Coriolis mass flow transmitter with Digital Signal Processing (DSP) and open architecture for easily enhanced and modified capabilities.

- Measure mass flow rate and total mass, density, temperature, standard and actual volumetric flow rate and total volume; concentration, Brix, Baumé, API and percent solids
- Patented Digital Signal Processing (DSP) technology
- Value-added design allows the user to select only the necessary options
- Weights & Measures approved for custody transfer applications
- Standard explosion-proof enclosure

NexGen® SFT200

The NexGen SFT200 greatly reduces the overall cost of the metering system in situations where the full capabilities of the Nexgen SFT100 are not required.

- The transmitter performs the basic functions of controlling and monitoring the mass flow transducer to determine the mass flow rate, the mass total, density, and temperature.
- Optional interface devices can provide ancillary functions and calculations such as batch control functions, net oil/net water measurements, or other functions.
- The transmitter can be configured through a PC with the Red Seal Measurement NexLink software.
- The Nexgen SFT200 can be mounted directly to the case of the transducer, or remotely mounted when operating conditions are not conducive to integral mounting.

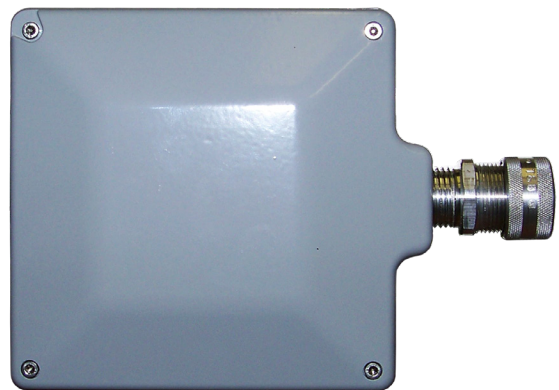

The NexGen SFT200 mass flow transmitter provides a small, efficient, low-cost control system for Red Seal Measurement mass flow transducers.



The Neptune DATAMATE2200™ Mass Flow Computer offers local control or interfacing to higher level control.

Neptune DATAMATE 2200™ Mass Flow Computer

The Neptune DATAMATE 2200™ offers stand-alone batching control or interfacing to higher level control instrumentation.

- Measures mass flow rate and total mass, density, temperature, standard and actual volumetric flow rate and total volume; concentration and percent solids, Net Oil (option).
- Preset (two-stage) batch control functions
- RS-485 Modbus communications
- Two user-programmable alarms with high or low output for each
- Diagnostic self-check capability
- Two standard user-programmable 4-20 mA outputs
- One standard quadrature pulse output

Volumetric Flowmeters

Mechanical volumetric flowmeters hold an important place in fluid processing. Our Neptune Type MP Oscillating Piston Flowmeter is particularly suited for nonpolar liquids with its leak-resistant design. The Neptune Type S Disc Flowmeter is tolerant of suspended solids that can interfere with the operation of many mechanical types.

The Neptune Type MP with Neptune PULSMATE™ Electronic Register provides anytime, anywhere process monitoring.

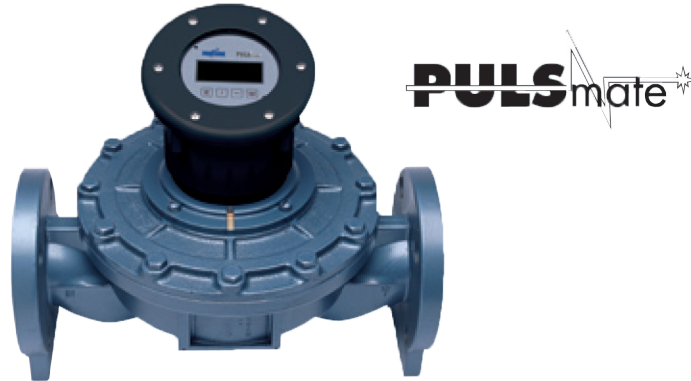

Neptune Type MP Oscillating Piston Flowmeter

This field-proven technology offers high environmental integrity. There are no dynamic mechanical seals and no stuffing box in the measuring chamber, providing exceptional leak resistance.

- Magnetic drive -- gear train is external and easily accessible
- Capillary seal design -- eliminates metal on metal contact
- Low-torque operation, even at low flow rates, for high accuracy: ± 0.5 , repeatability 0.1%
- Variety of engineered plastic piston materials to suit various fluid and temperature conditions
- Lightweight compact -- choice of cast iron, or stainless steel
- Choice of electronic or 100% mechanical batching capability -- no external power source required
- Neptune PULSMATE™ Electronic Register tracks both flow rate and cumulative volume, with scalable pulse output as standard and optional totalizers and 4-20 mA analog output
- Broad mechanical register options -- preset auto-stop, totalizer, pulse and analog outputs
- Pistons are available in bronze stainless steel or iron

The Neptune Type MP, an oscillating piston, magnetic drive flowmeter, is the heart of an accurate, consistent mechanical batching system.



Size	Flow Range		Working Pressure			
	mm	in.	litres/min	gpm	kg/cm ²	PSI
12.7 (NPT or ANSI flange)	1/2	4-38	1-10			
25.4	1 ANSI	26-265	7-70			
50.8	2 ANSI	57-568	15-150			
76.2	3 ANSI	113-1,136	30-300			

For straight measurement or batching, the Neptune Type S Disc Flowmeter offers century-proven technology, reliability and accuracy with all kinds of fluids.



Neptune Type S Disc Flowmeter

This versatile flowmeter is virtually unaffected by viscosity or flow profile disturbances. Remarkably forgiving, the Neptune Type S tolerates suspended solids that stall many other mechanical flow meter types.

- Functional -- ideal for inventory control, mechanical or electronic batching, totalizing, flow monitoring
- Durable -- glass phenolic or Ryton® discs
- Pressures to 10.2 bar (150 psi), temperatures to 121°C (250°F)
- ± 1% accuracy
- Neptune PULSMATE Electronic Register available for magnetic drive models (no stuffing box)
- Broad mechanical register options -- preset auto-stop, totalizer pulse and analog outputs

Size		Flow Range	
mm	in	litres/min	gpm ¹
19.1	3/4	11.4-114	3-30
25.4	1	19-189	5-50
50.8	2	60.6-606	16-160

¹Lower rates available on viscous applications.

The rugged bronze outer body components are compatible with hundreds of nonacidic liquids. Threaded end connections allow rapid conversion from right to left hand flow with provided coupling sets. Pulse transmitters, when used with the Neptune BATCHMATE 1500 electronic batch controller and a solenoid valve, provide an economical and dependable local or remote batching system.



Registers and Accessories

The Precision Digital 6830 Explosion-Proof Rate/Totalizer brings modern design, easy readability, and enhanced functionality to hazardous areas.



Precision Digital 6830

- Pulse, Open Collector, NPN, PNP, TTL, Switch Contact, Sine Wave (Coil), Square Wave, Opto-Isolated Inputs
- Explosion-Proof, IP68, NEMA 4X Enclosure
- 5-Digit 0.7" (17.8 mm) Top Display for Rate or Total
- 7 Alphanumeric Character 0.4" (10.2 mm) Lower Display for Rate, Total, Grand Total, Units, and Tag
- 13-Digit Totalizer with Total Overflow Feature
- Isolated 4-20 mA Output for Rate, Total, or Grand Total
- Battery, DC, or Output Loop-Powered Models
- Automatic Rate, Total, and Grand Total Unit Conversions
- Password Protection
- Backlight Standard on All Models
- Flanges for Wall or Pipe Mounting
- Operates from -40 to 75°C

The Neptune BATCHMATE 1500™ is a flexible, easily configured batching controller for use with Red Seal Measurement mechanical flowmeters.



Neptune BATCHMATE 1500® Batch Controller

- K-factor programmable to 8 places
- Pulse or analog input (with totalizing integration)
- Scaled pulse or optional 4-20mA analog outputs
- Displays total, rate or grand total
- 20 KHz count speed
- Two-way RS-232/422 communications
- Batcher with two-stage control
- Optional 16-point linearization
- Missing pulse detection

The Neptune PULSMATE Electronic Register offers enhanced capabilities for new or existing Neptune Type MP and magnetic drive Neptune Type S flowmeters, combining features of localized registration and a flow computer.



Neptune PULSMATE® Electronic Register

- Displays both flow rate and cumulative volume simultaneously, with optional high-low rate alarm
- Standard scalable pulse output for process monitoring anytime, anywhere
- Optional 4-20mA analog output for remote rate indication
- Selectable totalizer modules, resettable and non-resettable (cumulative)
- Retrofittable to existing magnetic drive flowmeters
- Electronic calibration for fast set up; no need for mechanical change gears
- Durable Engineering Thermoplastic Polyurethane (ETPU) housing is stable, tough and chemically inert

Pulse transmitters and contact closure switches aid the configuration of batching operations.



Signal Transmitters and Switches for Mechanical Registers

- Contact closure and solid state square wave output
- UL- and CSA-listed explosion-proof enclosures (CE version available)
- High-resolution for small batch accuracy
- Pulse output transmitters
- Counter-activated switches for remote actuation of pumps and valves and for batch counting

The E:Count LT is a single product register generally used in stationary applications.



Mid:Com E:Count LT

- Pulse input/output
- Backlit display
- 2 auxiliary inputs - 4 auxiliary outputs
- I/O customized software available
- Volume displayed in Gallons or Liters
- Mass displayed in Pounds or Kilograms
- Display can also show flow rate and total
- Whole units or one or two decimal places
- Serial port for peripheral connections
- Pump and valve control

Specialized Flowmeters

Red Seal Measurement offers a range of flowmeters for special applications. These include the Type VLF Very Low Flow Flowmeters and an ink flowmeter for printing presses and very high pressure applications. Whatever your industrial flow measurement need, call us -- we have the technology to fill your needs.

The Red Seal Measurement Ink/High Pressure Flowmeter offers accurate measurement of ink consumption on printing presses.

Type VLF Very Low Flowmeters are often used to improve measurement of fuel oil to boilers in steam generations systems.



Meter Type	Size		Flow Range		Working Temperature		Working Pressure		Materials, Wetted Parts
	mm	in.	litres/hr	gph	°C	°F	kg/cm ²	PSI	
VLF 4	3.2	1/8	1-80	0.25-20	60	140	25	350 ¹	Brass/aluminum
VLF 8	9.5	3/8	4-200	1-50	60	140	25	350 ¹	Brass/aluminum
VLF 20	19.1	3/4	34-1,476	9-390	130	260	16	225 ¹	Brass/aluminum
INK	15.8x25.4	5/8x1	0.9-9.4	0.25-2.5 ²	121	250	350	5,000	Steel/bronze/phenolic

¹Maximum pressure.

² Flow range in litres/min (gpm).

Typical Flowmeter Applications

Flowmeter Type	Steam	Gas	Water	Slurries	Corrosives	Abrasives	Solvents/ Fuels	Max. Accuracy, %±	Repeatability, %±
m ® Coriolis Mass	Yes ¹	Yes ¹	Yes	Yes	Yes	Yes	Yes	0.10 (mass) 0.0008 (density)	0.1 (mass) 0.0002 (density)
Type MP	No	No	Yes	No	Yes	No	Yes	0.5	0.1
Type S	No	No	Yes	Yes	No	No	Yes	1	NA
Type VLF	No	No	No	No	No	No	Yes	1.0	NA

This chart is intended as a general guide only. Contact your RSM representative for experienced applications assistance relating to your specific needs.
¹Consult the factory for gas applications.

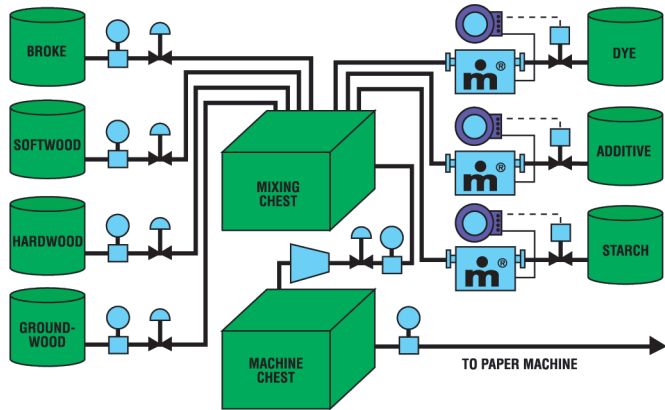

Additive blending

Mass flowmeters control metering of additives with the highest possible accuracy for outstanding sheet uniformity and consistency.

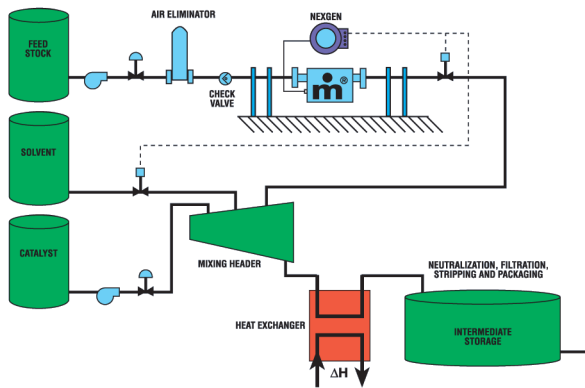

Process control

A mass flowmeter controls precise metering of expensive catalyst, providing improved product consistency and material savings.

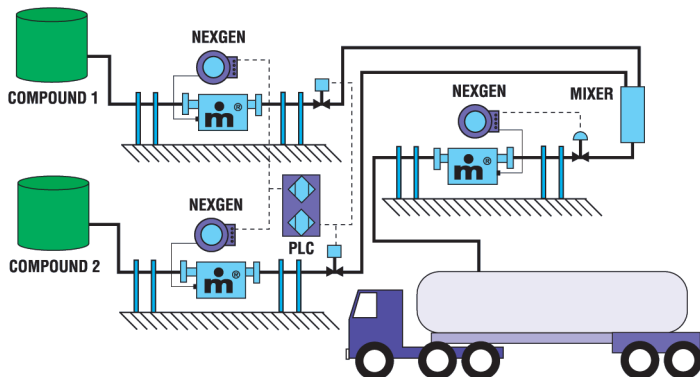

Mass-based blending

Mass flowmeters excel controlling ratios of two or more starting compounds with different densities. The PLC drives the NexGen Mass Flow Transmitters to achieve the desired ratio; it also controls the valves. A third mass flowmeter loads end product with custody transfer accuracy.

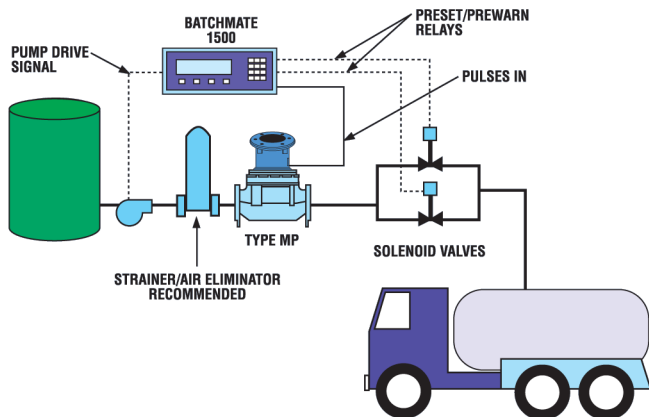
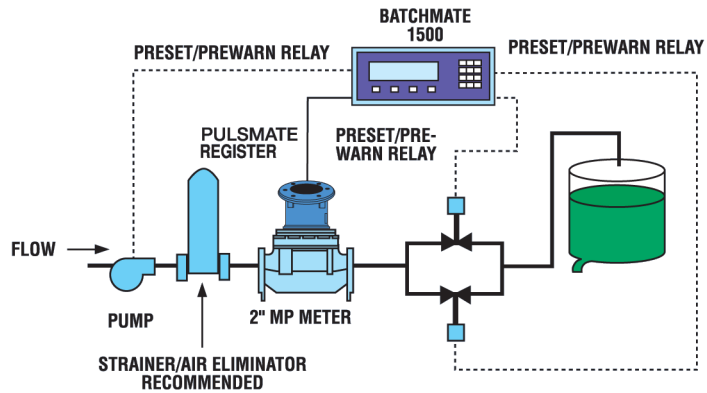
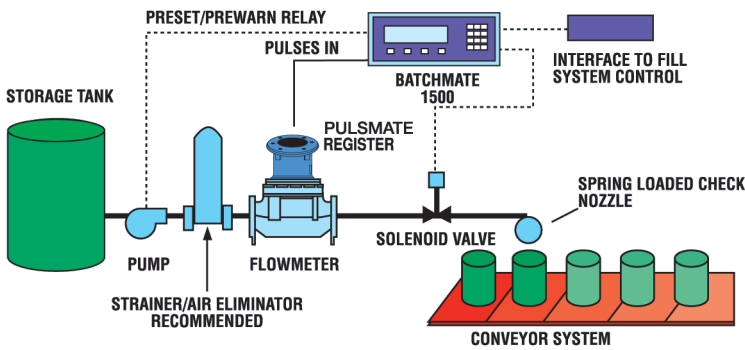
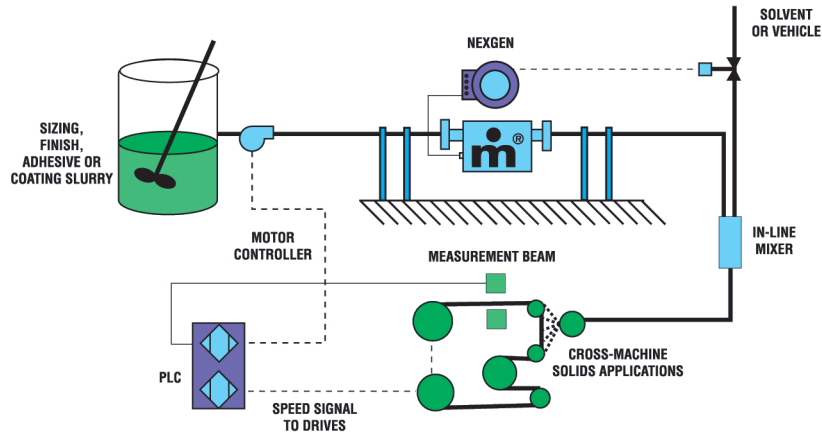

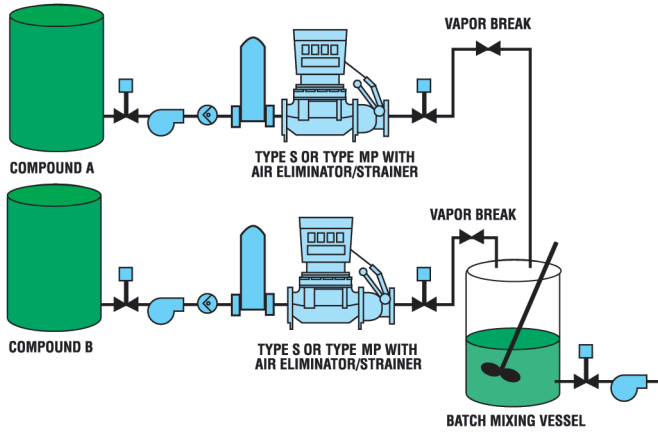

Mechanical batching

A Type MP Oscillating Piston Flowmeter, a Series 800 Register with preset and an auto-stop valve constitute a 100% mechanical batching system -- accurate and repeatable.

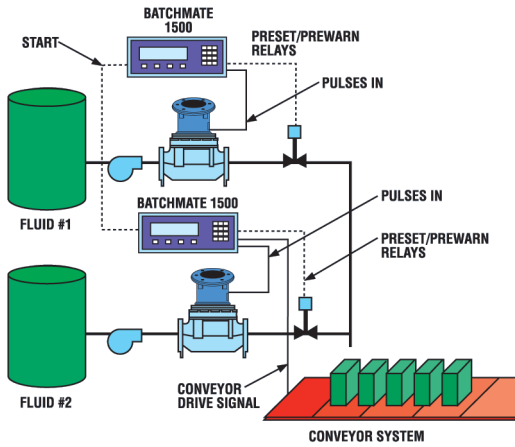

Dual ingredient blending

BATCHMATE 1 delivers a preset quantity to a container, then transmits a signal to close valve No. 1 and a second signal to the "start" switch of BATCHMATE 2. After reaching its preset quantity, BATCHMATE 2 signals the conveyor drive and energizes the "start" switch on BATCHMATE 1. The sequence begins again.

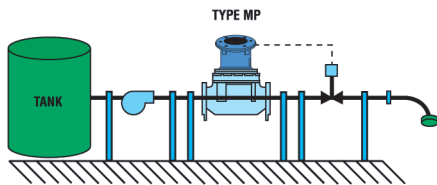

Agricultural fluid transfer

The stainless steel type MP Oscillating Piston Flowmeter with PULSMATE Electronic Register offers exceptional accuracy and cost efficiency for a wide range of agricultural fluids.

1310 Emerald Road
Greenwood, SC 29646
USA
Phone: 1.800.833.3357
Fax: 1.864.223.0341

